



## ***KAPLANTRADERS PRODUCT RANGE***

We as kaplantraders offer different range of product scales and we are open to all sorts of products proposals offered by your esteemed company.

### **MEDICAL PRODUCTS**





Quality Control  
**Human First**  
 performance  
 global  
 creative  
 CE  
 integrated  
**engineering**

ISO 13485:2003  
 creative  
 ISO 9001:2008  
 R&D  
 innovative  
 Technology

**High Quality**  
 traceability

**reliable**  
 Free Sale Certificate  
**manufacturer**

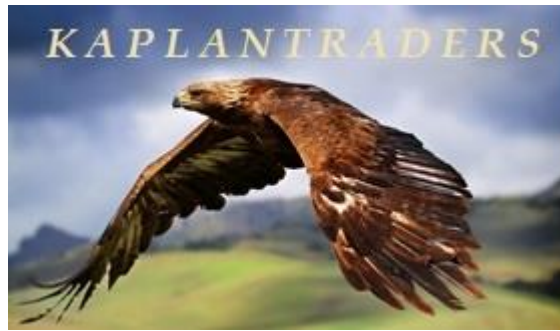

## **TRAUMA PLATES AND SCREWS**

**-Upper Extremity Plates**

**-Lower Extremity Plates**

**-Pediatric Plates**

**-Mini Plates**

## **SPINAL SYSTEM & SCREWS**

## **INTRAMEDULLARY NAILS**

## **HIP PROSTHESIS**

## **KNEE PROSTHESIS**

## **ORTHOPEDIC & SPINAL HAND INSTRUMENTS SET**

**-Knee Instrument Sets**

**-Hip Instrument Sets**

**-Various Trauma Instrument Sets**

**-Spine Instrument Sets**



## **TRAUMA PLATES AND SCREWS**

### **-Upper Extremity Plates**



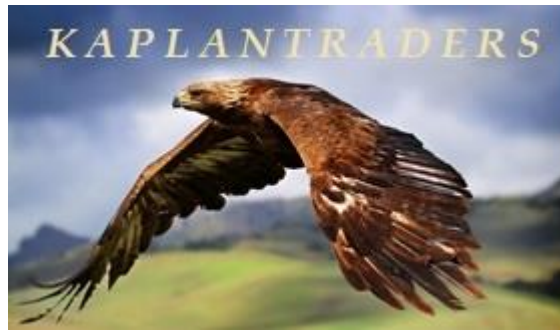

**-Lower Extremity Plates**





### -PediatricPlates



### -Mini Plates

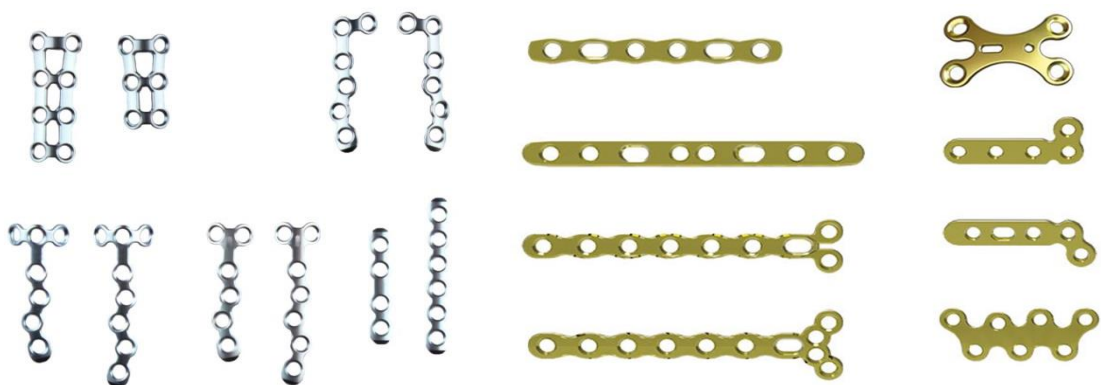

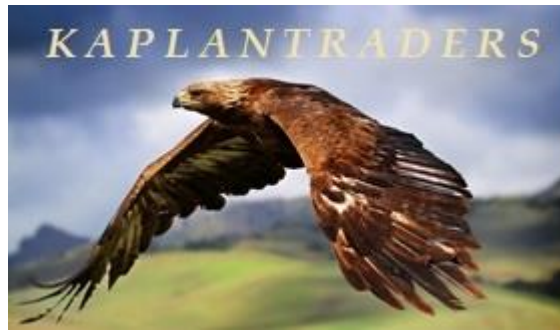

## SPINAL SYSTEM & SCREWS

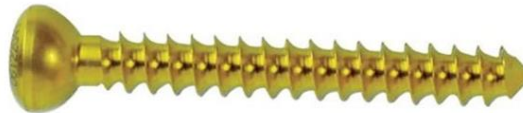





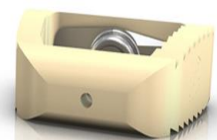
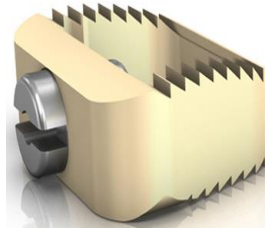
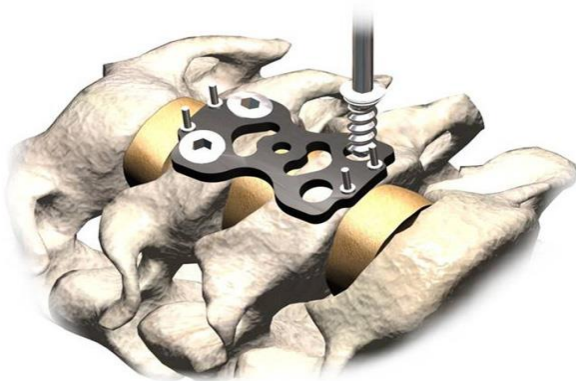

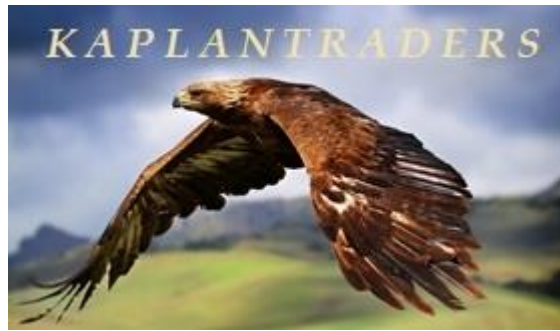

## INTRAMEDULLARY NAILS





## HIP PROSTHESIS

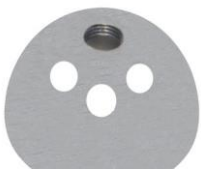



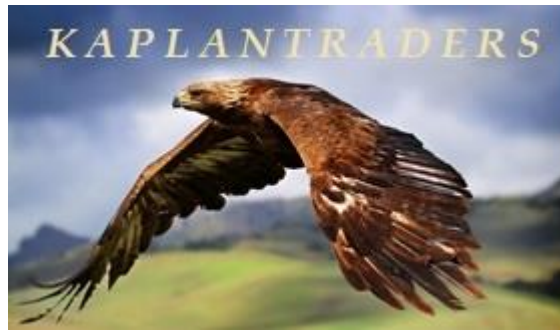

## KNEE PROSTHESIS





## ORTHOPEDIC & SPINAL HAND INSTRUMENTS SET

### -Knee Instrument Sets

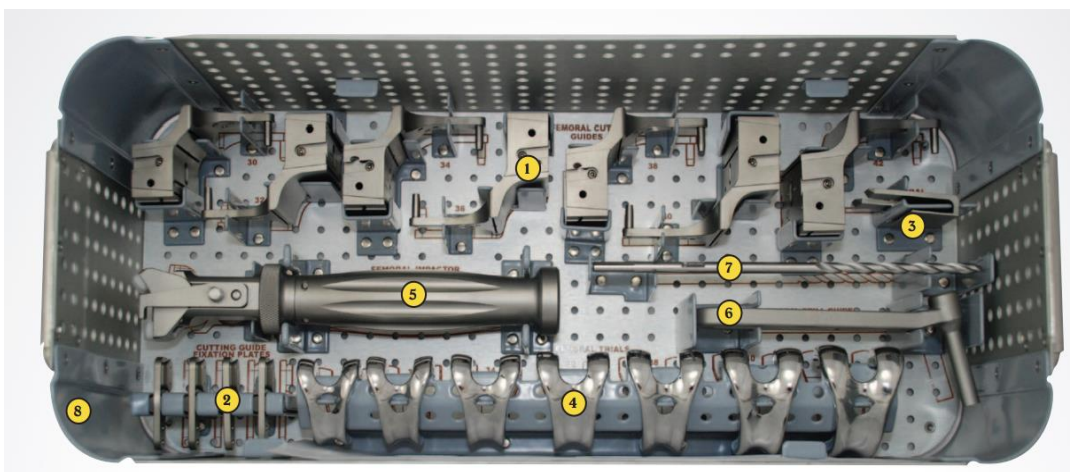
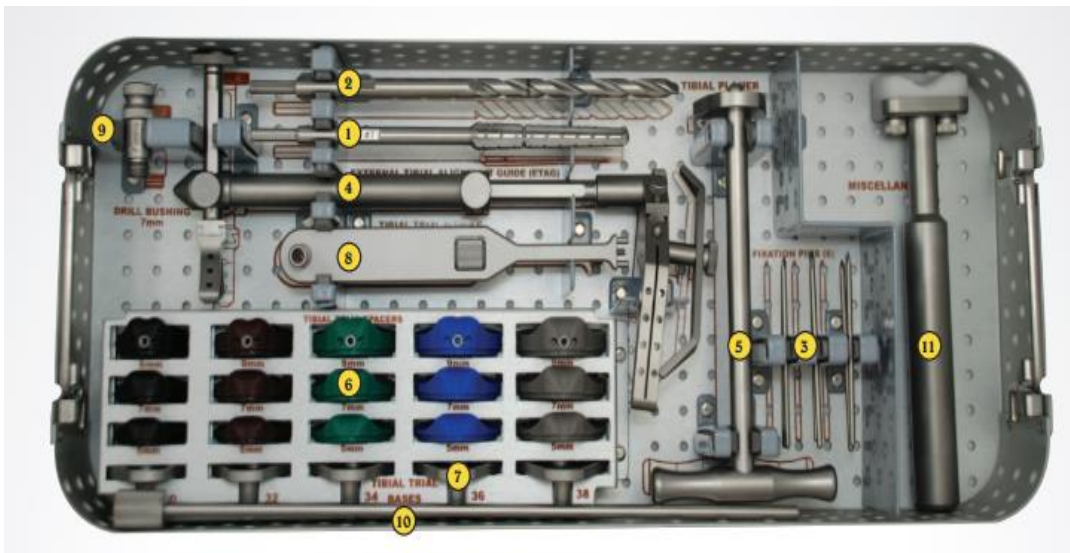

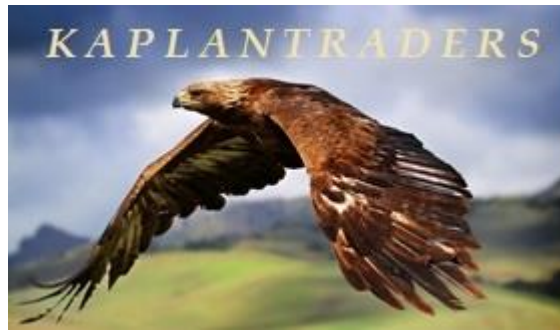

## -Hip Instrument Sets

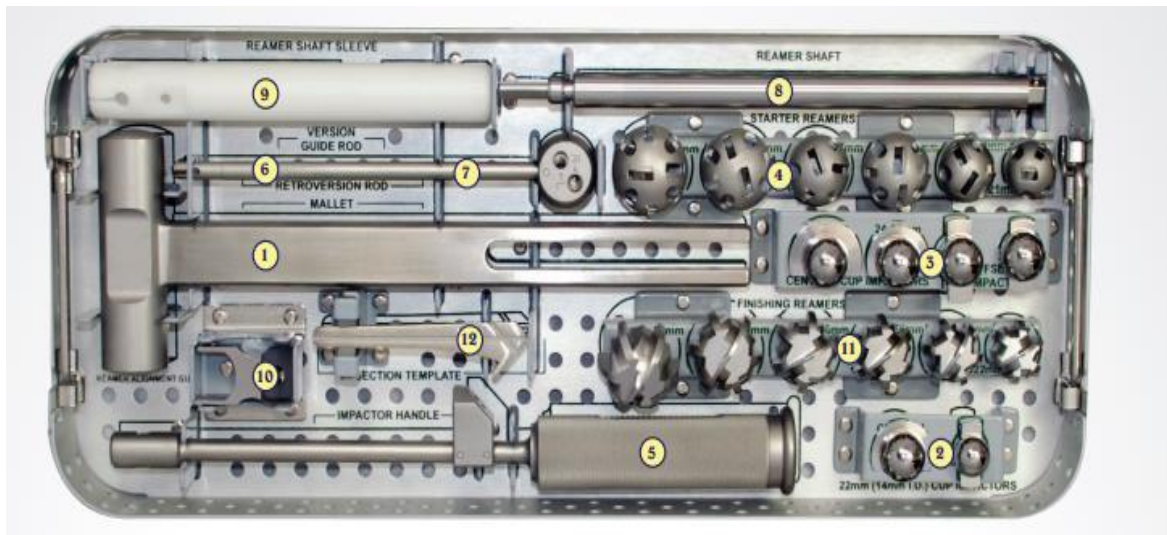

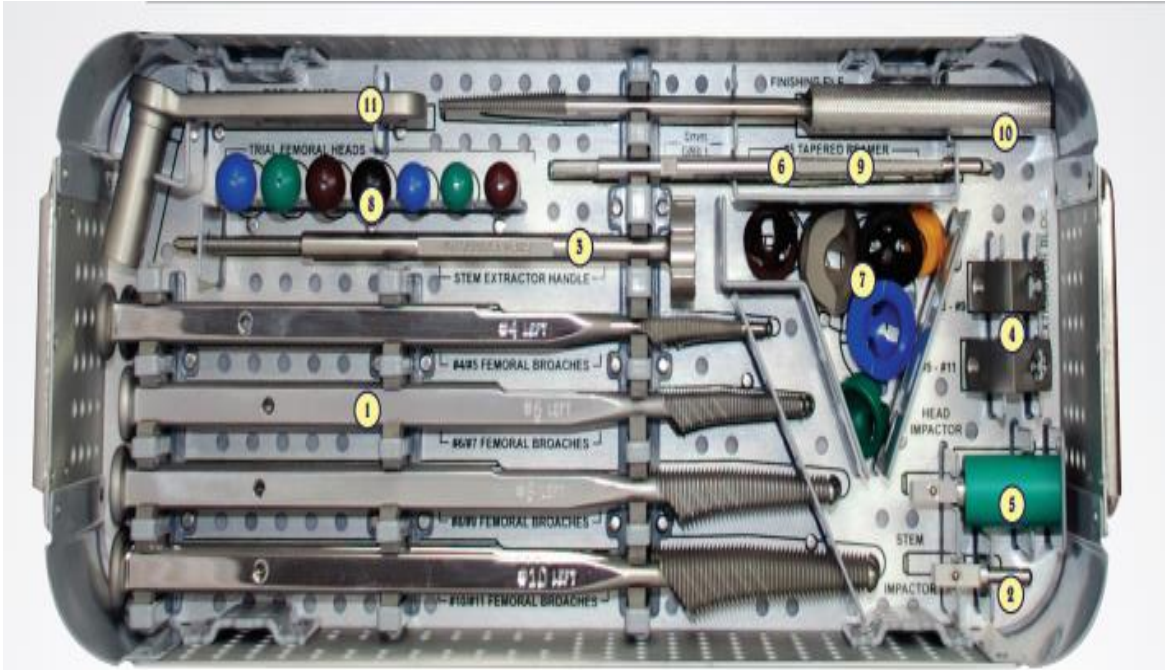



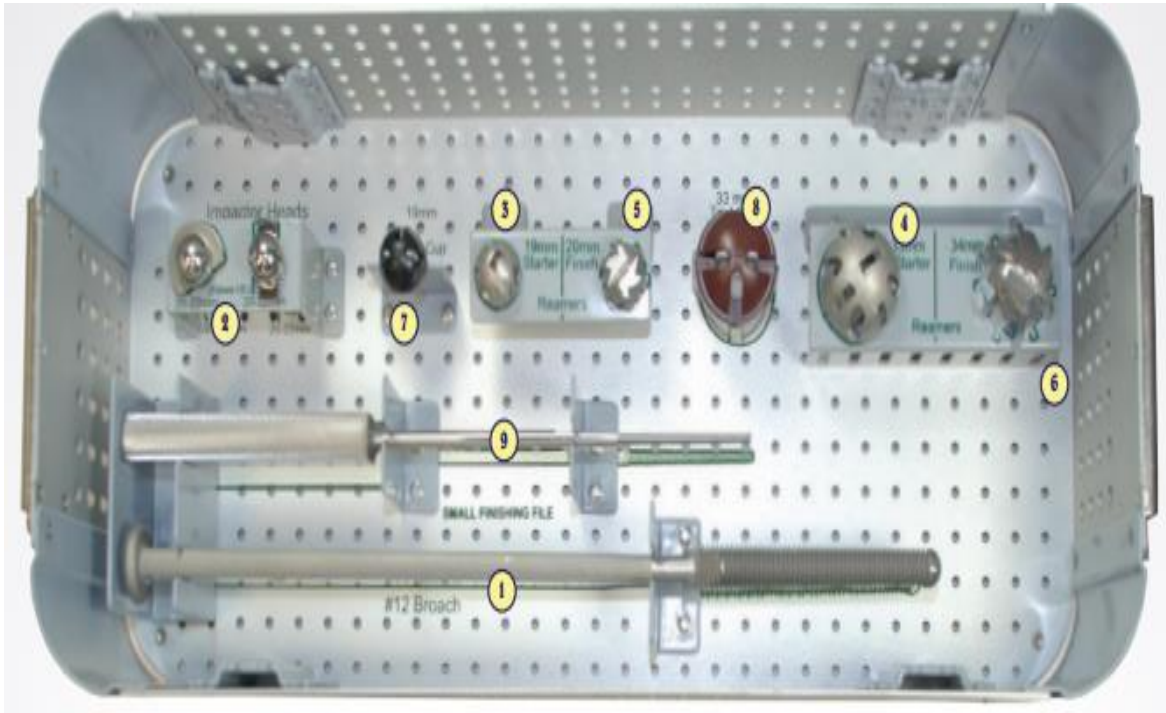

## Spine Instrument Sets



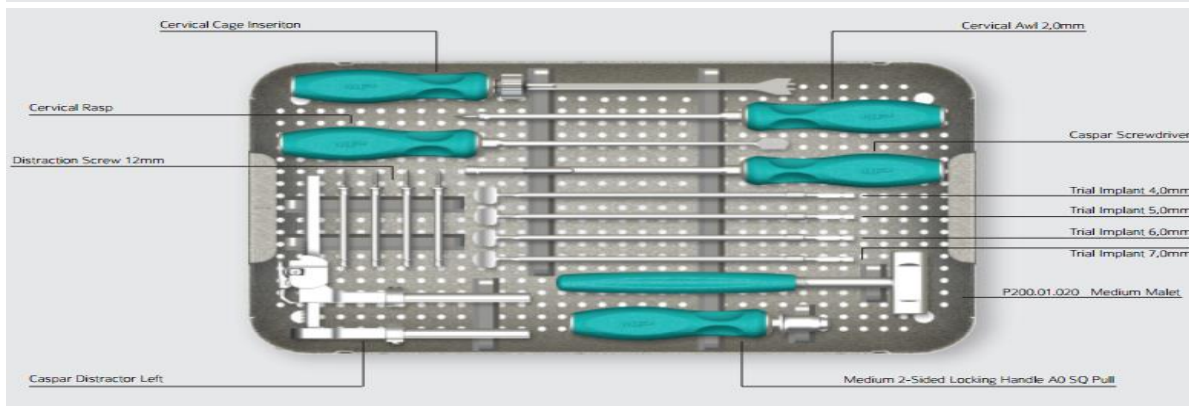
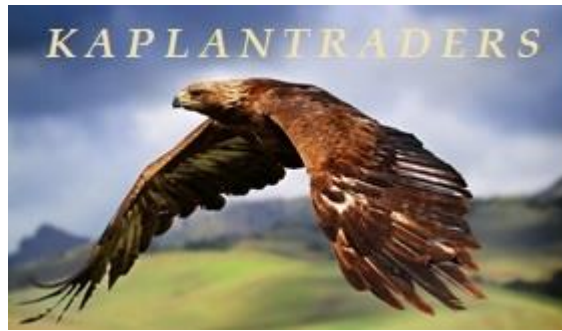

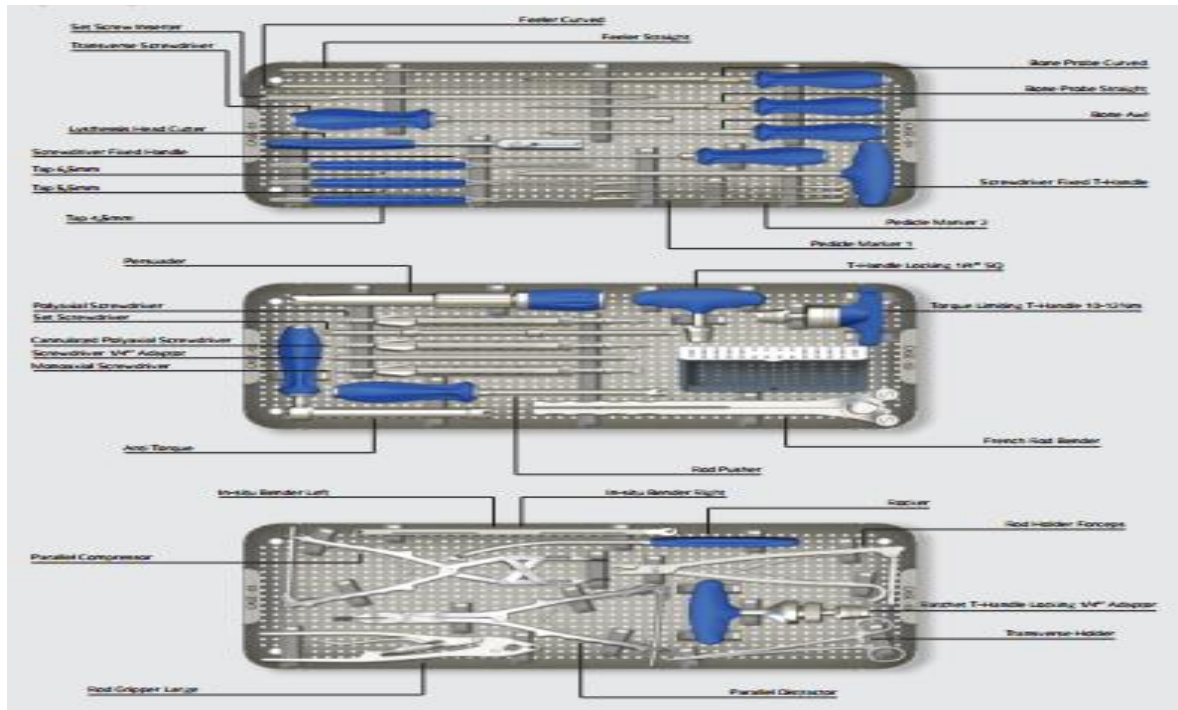
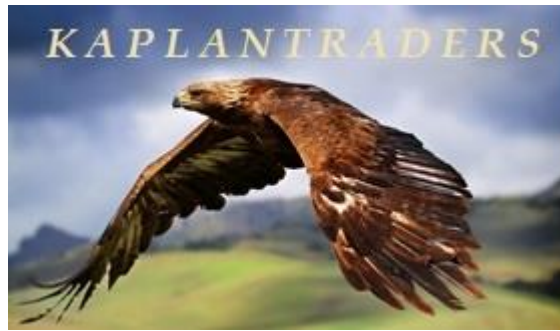

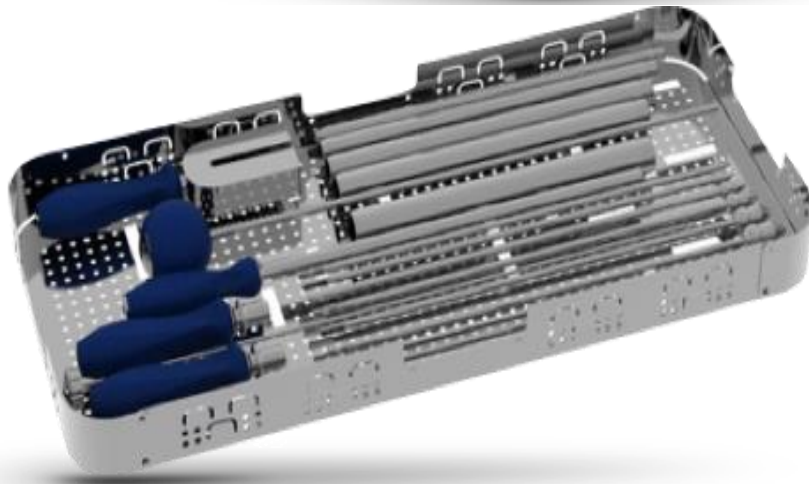
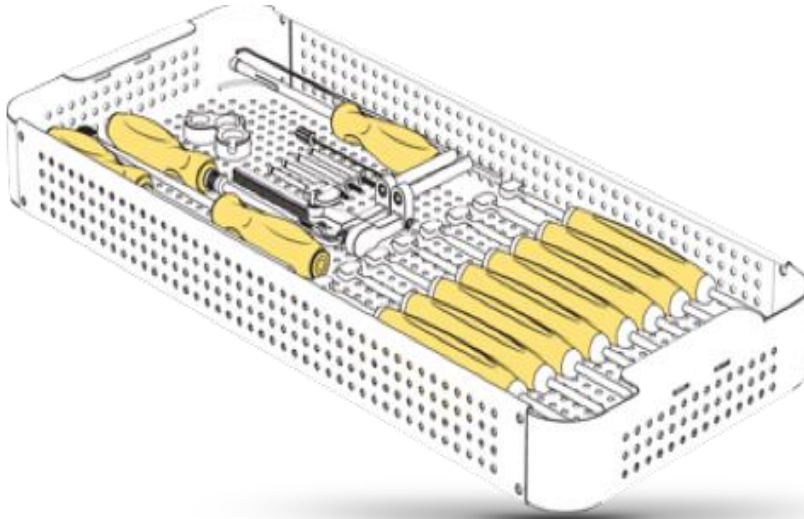

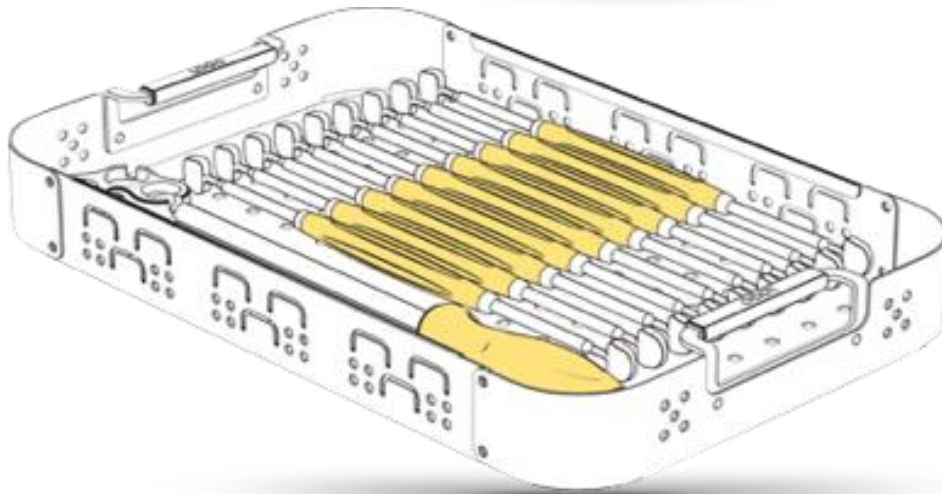
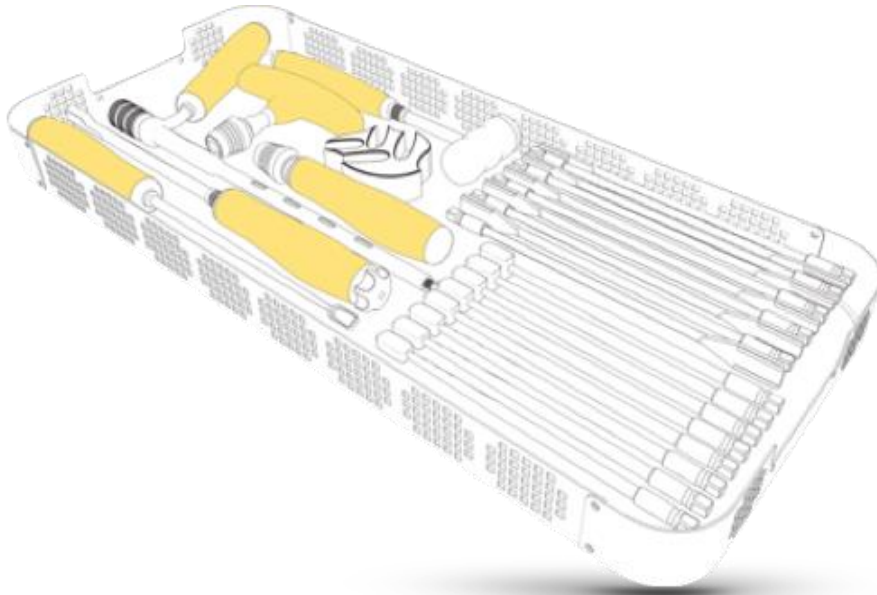

*Thank  
you*

A close-up image of a fountain pen nib, showing the gold-colored metal and the black resin of the pen body.